



§ SPECIFICATION APPROVAL SHEET §

Fdt Tech Module No: **LOF104X13P-00R**

Description: **10.4" Digital TFT-LCD Module**

SPEC No.: **SAS-1404002**

Version: **1.0**

Issue Date: **October 6, 2014**

※ This approval sheet contains 22 pages including the cover and appendix.

Customer:	Approved By:
Date: / / 14	

Approved By: _____ Checked By: _____ Designed By: _____



1. General Description

1.1 Features

- 10.4" (1024x768) Digital TFT LCD
- Aspect Ratio: 4:3
- Input Signal VGA / DVI-D / HDMI 1.3a
- Maximum Support Resolution 1920x1080
- Stereo Audio Amplifier, Output 2W@4Ω Speaker
- Audio Line-In / Line-Out (Optional)
- 2 Points Projected Capacitive Touch
- 5 Key Buttons Controls
- UART / RS232 Serial Remote Control (Optional)
- 8 Language OSD Menu
- Light Sensor (Optional)
- LED Backlight
- Wide Operation Voltage +11V ~ +28V

1.2 Applications

- Industrial
- Medical Environment
- Instrument Display
- Kiosk
- Security
- Signage
- Office Electronics
- Home Application
- Educate Application



2. Contents

Contents	Page
1. General Description	1
1.1 Features	1
1.2 Applications	1
2. Contents	2-3
3. Specifications	4
4. Block Diagram	4
5. TFT-LCD Information	5
5.1 TFT-LCD Mechanical Specifications	5
5.2 TFT-LCD Optical Characteristics	5
6. Order Information	6
6.1 Unit	6
7. Dimension Information	7
7.1 Unit (LOF104X13P-00R)	7
8. Pin Description	8-11
8.1 DC-In : Pin Assignment of Power Input (DC-Jack Inside Diameter:2.1 ϕ Outside Diameter:5.5 ϕ Side Entry Type)	8
8.2 VGA : Pin Assignment of Analog RGB Input (D-Sub 15Pin)	8
8.3 DVI : Pin Assignment of DVI-D (24 Pin)	9
8.4 HDMI : Pin Assignment of HDMI-A Type Input (HDMI 1.3a -19Pin Female)	10
8.5 L : Pin Assignment of Speaker Left (Pitch 2.0mm 2Pin , Top Entry Type)	10
8.6 R : Pin Assignment of Speaker Right (Pitch 2.0mm 2Pin , Top Entry Type)	11
8.7 USB Port : Pin Assignment of Touch USB (USB A Type - Female 2.0mm, Side Entry Type)	11
8.8 Line-In : Pin Assignment of Line-In/Out (Option) (Outside Diameter:3.5 ϕ Side Entry Type)	11
9. Absolute Maximum Ratings	12
9.1 Absolute Maximum Ratings	12
10. Recommended Operating Conditions	12
10.1 Electrical Characteristics	12
10.2 Support Display Mode Characteristics	12
11. Projected Capacitive Touch Panel Characteristics	13-16
11.1 Electrical Performance	13
11.2 Optical Performance	13
11.3 Mechanical Performance	13
11.4 Touch Panel Operation System Support	13
11.5 Panel Mount Installation (Mount Clamp and Screw)	14
12. Installing the Monitor	15
12.1 Power cable connection	15
12.2 VGA signal cable connection	15



12.3 Switch on the power	15
<i>13. Accessories (Option).....</i>	16
<i>14. Key Function by OSD.....</i>	17-20
14.1 Menu Operation	17-20

3. Specifications

LCD	
Panel Size	10.4"
Resolution (Pixels)	1024x768
Color	262K
Luminance w/o TP	400 cd/m ²
Luminance (PCT)	348 cd/m ²
Contrast Ratio	500
View Angle	75 / 75 / 60 / 80
Backlight Life Time (LED)	30K (Min)
Power Requirement	
Power Input (DC Jack 2.1 φ)	+11V ~ +28V _{DC}
Power Consumption@+12V	6.6 Watts (@Without Amplifier)
Touch Screen	
Projected Capacitive Touch	USB Interface (2 Points)
Projected Capacitive Touch Support OS	Windows / Android / Linux

Input Signal	
VGA	D-Sub15
DVI	DVI-D
HDMI	1.3a
Audio	
Amplifier	1W@8Ω / 2W@4Ω
Line-In	Stereo Input Phone Jack φ 3.5
Controls	
Key	5 Buttons
Serial Remote Control	UART / RS232 (Optional)
Environment	
Operating Temp. PCT	-20~+70°C
Storage Temp. PCT	-20~+70°C

4. Block Diagram

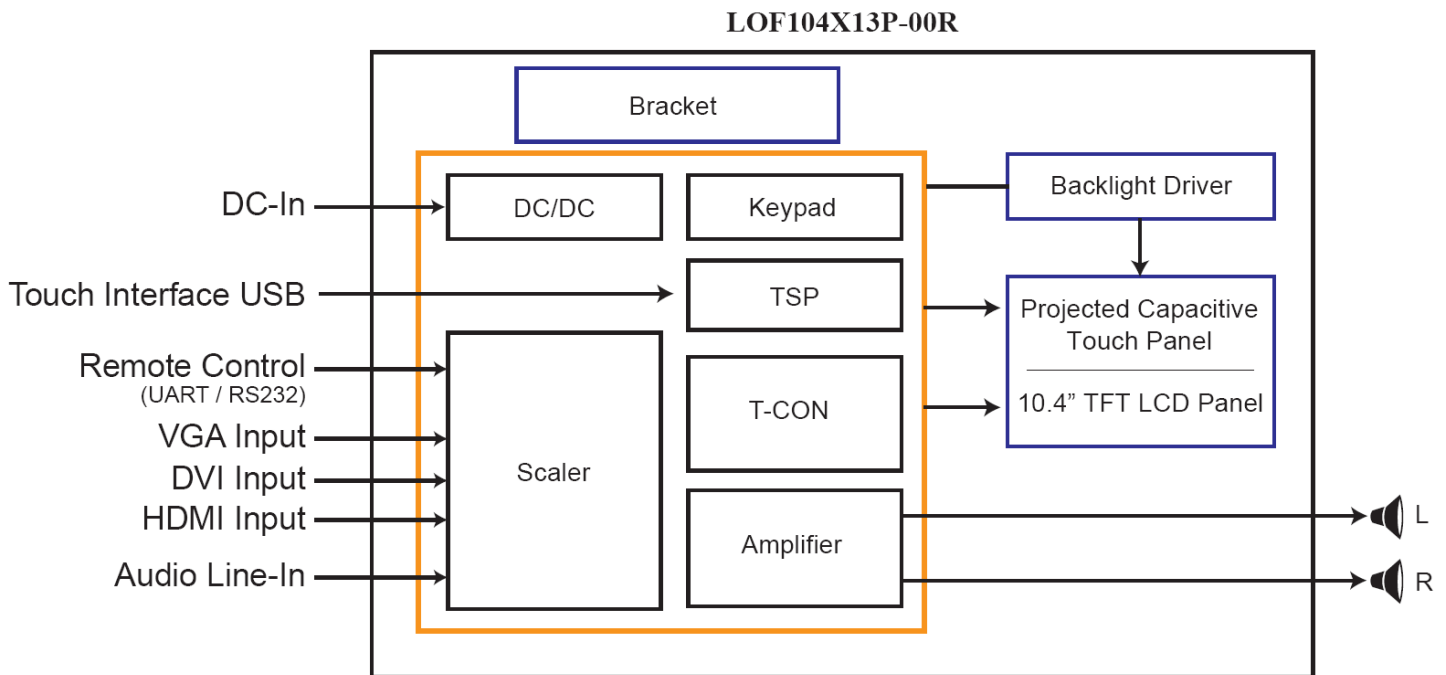



5. TFT-LCD Information

5.1 TFT-LCD Mechanical Specifications

Parameter	Specifications	Unit
Screen Size	10.4 (diagonal)	Inch
Display Format	1024 x (R.G.B) x 768	Dot
Active Area	211.2(H) x 158.4(V)	mm
Pixel Pitch	0.20625(H) x 0.20625(V)	mm
Pixel Arrangement	RGB vertical stripe	
Surface Treatment	Anti-Glare, Hard Coating (3H)	

5.2 TFT-LCD Optical Characteristics

Parameter	Symbol	Condition	Min	Typ	Max	Unit	Remark
Viewing Angle	Horizontal	Left	65	75	---	deg	
		Right	65	75	---	deg	
	Vertical	Top	50	60	---	deg	
		Bottom	70	80	---	deg	
Contrast Ratio	CR	At optimized Viewing angle	400	500	---	---	
Luminance w/o PCT	L		320	400	---	cd/m ²	
Backlight Life Time (LED)		25°C	30000	---	---	Hrs	



6. Order Information

6.1 Unit

Parameter	LOF104X13P-00R
VGA	⊙
DVI	⊙
HDMI	⊙
Touch Panel Type	Projected Capacitive Touch
Touch Screen Interface	USB
Audio Amplifier	⊙
Audio Line-In	⊙
5 Keys	⊙
UART Remote Control	⊙

Note: 1.The assembling of panel and bracket is aimed for delivery, packaging and experiment. If the demand of shockproof and long-term fix, pls have it into consideration of mechanism design.

Optional Functions	
Parameter	<ul style="list-style-type: none"> - Audio Line-Out - RS232 Remote Control - Light Sensor - Accessories (Option)

7. Dimension Information

7.1 Unit (LOF104X13P-00R)

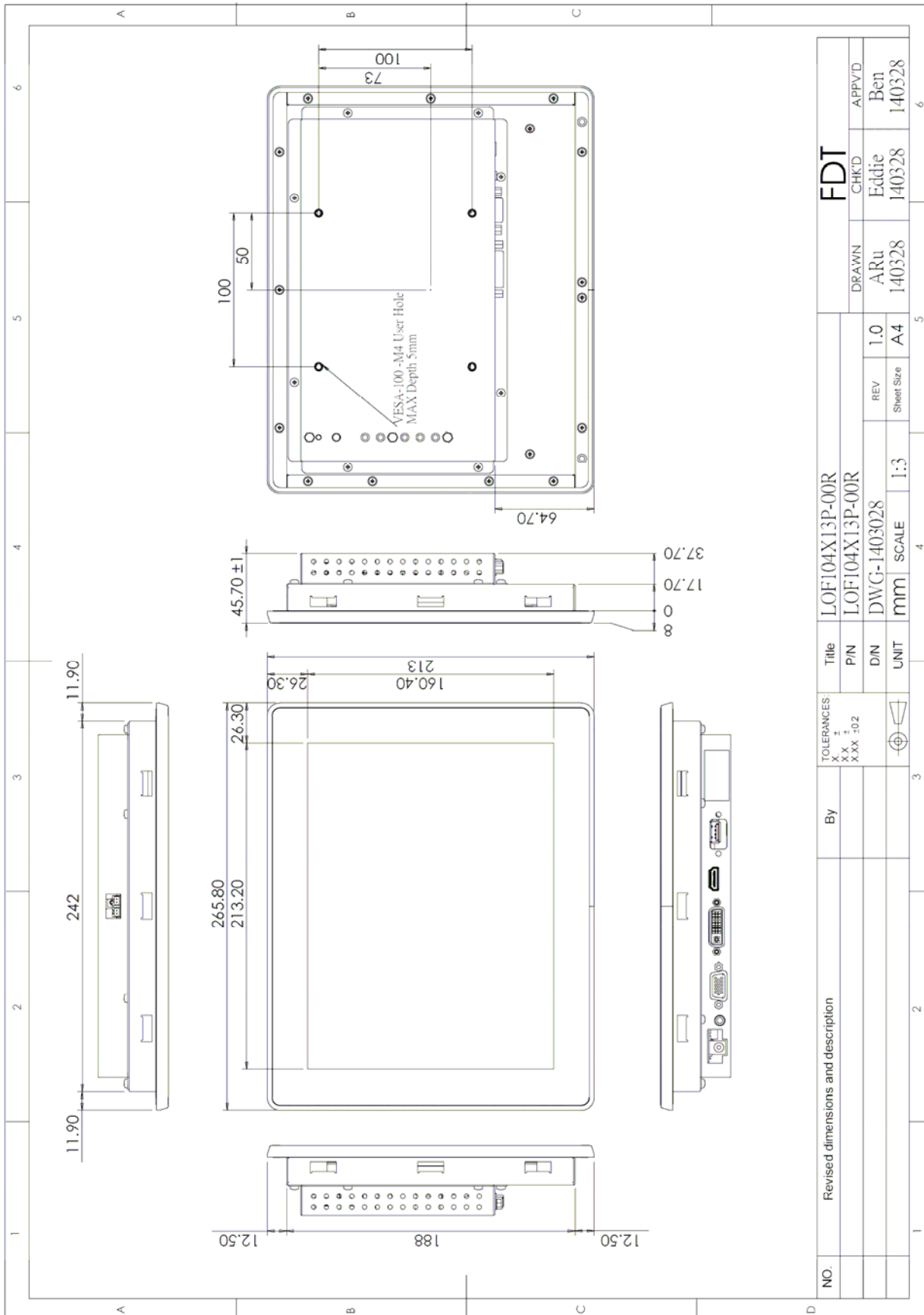

8. Pin Description

8.1 DC-In : Pin Assignment of Power Input (DC Jack Inside Diameter:2.1 ϕ Outside Diameter:5.5 ϕ Side Entry Type)

Pin No.	Symbol	I/O	Description	Remark
1	DC-In	I	+11~+28 Vdc Input Voltage	
2	GND	-	Power Ground	

8.2 VGA : Pin Assignment of Analog RGB Input (D-Sub 15Pin)

Pin No.	Symbol	I/O	Description	Remark
1	RI+	I	Analog Red Signal	
2	GI+	I	Analog Green Signal	
3	BI+	I	Analog Blue Signal	
4	GND	-	Ground	
5	VGA-Det	I	VGA Detect	
6	AGND	-	Analog Ground	
7	AGND	-	Analog Ground	
8	AGND	-	Analog Ground	
9	VGA5V	-	VGA +5Vdc Input	
10	GND	-	Ground	
11	GND	-	Ground	
12	VGA_SDA	-	DDC2 Data	
13	HS_IN	I	TTL Horizontal sync.	
14	VS_IN	I	TTL Vertical sync.	
15	VGA_SCL	-	DDC2 Clock	

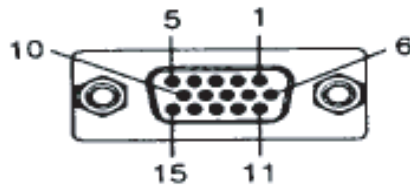

8.3 DVI : Pin Assignment of DVI-D (24 Pin)

Pin No.	Symbol	I/O	Description	Remark
1	DATA2-	I	Negative DVI Input for A Link Data Channel 2	
2	DATA2+	I	Positive DVI Input for A Link Data Channel 2	
3	GND	-	Ground	
4	NC	-	No Connection	
5	NC	-	No Connection	
6	DVI_SCL	I	DDC2 Clock	
7	DVI_SDA	I	DDC2 Data	
8	NC	-	No Connection	
9	DATA1-	I	Negative DVI Input for A Link Data Channel 1	
10	DATA1+	I	Positive DVI Input for A Link Data Channel 1	
11	GND	-	Ground	
12	NC	-	No Connection	
13	NC	-	No Connection	
14	DVI5V	I	DVI +5Vdc Input	
15	DET_DVI	I	DVI Detect	
16	DVI_HPD	-	Hot Plug Detect	
17	DATA0-	I	Negative DVI Input for A Link Data Channel 0	
18	DATA0+	I	Positive DVI Input for A Link Data Channel 0	
19	GND	-	Ground	
20	NC	-	No Connection	
21	NC	-	No Connection	
22	GND	-	Ground	
23	DCLK+	I	Positive DVI Input for A Link Clock Channel	
24	DCLK-	I	Negative DVI Input for A Link Clock Channel	

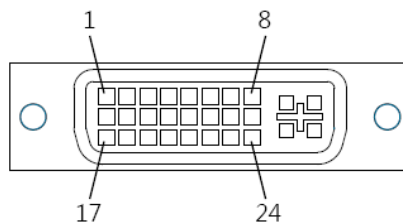

8.4 HDMI : Pin Assignment of HDMI-A Type Input (HDMI 1.3a -19Pin Female)

Pin No.	Symbol	I/O	Description	Remark
1	DATA2+	I	Positive HDMI Input for B Link Data Channel 2	
2	DET_HDMI	-	HDMI Detect	
3	DATA2-	I	Negative HDMI Input for B Link Data Channel 2	
4	DATA1+	I	Positive HDMI Input for B Link Data Channel 1	
5	GND	-	Ground	
6	DATA1-	I	Negative HDMI Input for B Link Data Channel 1	
7	DATA0+	I	Positive HDMI Input for B Link Data Channel 0	
8	GND	-	Ground	
9	DATA0-	I	Negative HDMI Input for B Link Data Channel 0	
10	DCLK+	I	Positive HDMI Input for B Link Clock Channel	
11	GND	-	Ground	
12	DCLK-	I	Negative HDMI Input for B Link Clock Channel	
13	NC	-	No Connection	
14	NC	-	No Connection	
15	HDMI_SCL	I	DDC2 Clock	
16	HDMI_SDA	I	DDC2 Data	
17	GND	I	DDC/CEC Ground	
18	HDMI5V	I	HDMI +5Vdc Input	
19	HDMI_HPD	I	Hot Plug Detect	

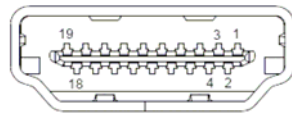

8.5 L : Pin Assignment of Speaker Left (Pitch 2.0mm 2Pin , Top Entry Type)

※ FDT Connector Part No.: A2001WV2-2P(JWT) ;

※ FDT Matching Connector Part No.: A2001H02-2P(JWT) .

Pin No.	Symbol	I/O	Description	Remark
1	+LOUT	O	Left Speaker Out+	
2	-LOUT	O	Left Speaker Out -	

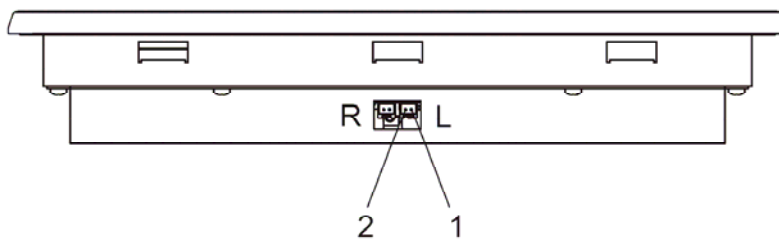

8.6 R : Pin Assignment of Speaker Right (Pitch 2.0mm 2Pin , Top Entry Type)

※ FDT Connector Part No.: A2001WV2-2P(JWT) ;

※ FDT Matching Connector Part No.: A2001H02-2P(JWT) .

Pin No.	Symbol	I/O	Description	Remark
1	+ROUT	O	Right Speaker Out+	
2	-ROUT	O	Right Speaker Out-	

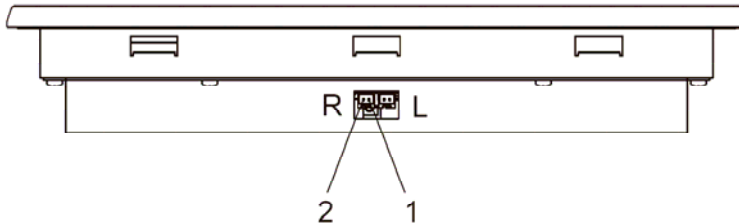

8.7 USB Port : Pin Assignment of Touch USB (USB A Type - Female 2.0mm, Side Entry Type)

Pin No.	Symbol	I/O	Description	Remark
1	VBUS	-	USB VCC	
2	D-	-	DATA (-)	
3	D+	-	DATA (+)	
4	DGND	-	Digital Ground	

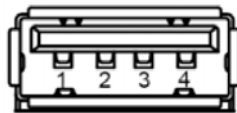

8.8 Line-In : Pin Assignment of Line-In/Out (Option) (Outside Diameter:3.5 φSide Entry Type)

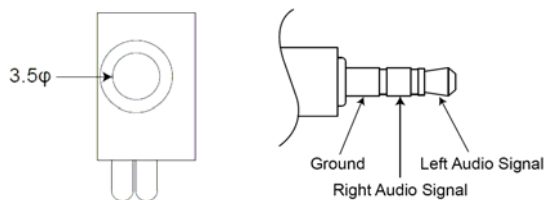



9. Absolute Maximum Ratings

9.1 Absolute Maximum Ratings

Parameter	Symbol	Min	Max	Unit	Remark
Input Voltage	Vin	10.5	28.5	V	
Analog RGB Input Signal	Analog RGB in	0.5	2.0	Vp-p	
Digital Input Signal	TTL	0.3	3.6	V	
DVI Input Signal		-	165	MHz	
HDMI Input Signal		-	165	MHz	
Line-in			1.8	Vp-p	
Operating Temp.		-20	+70	°C	
Storage Temp.		-20	+70	°C	

10. Recommended Operating Conditions

10.1 Electrical Characteristics

Parameter	Symbol	I/O	Min	Typ	Max	Unit	Note
Input Voltage	DC-in	I	11	12	28	V	
Total Current	I-in	I		550		mA	+12V
Power Consumption		I		6.6		W	@Without Amplifier
Output Voltage	VDD	O	3.2	3.3	3.4	V	
Analog RGB Input Signal	Analog RGB in	RGB		0.7		Vp-p	@75Ω
DVI Input Signal					165	MHz	
HDMI Input Signal					165	MHz	

10.2 Support Display Mode Characteristics

Dots per inch	H	Unit	Polarity	V	Unit	Polarity	Note
640*480	31.47	KHz	Positive	59.9	Hz	Positive	
800*600	37.88	KHz	Positive	60.3	Hz	Positive	
1024*768	48.36	KHz	Positive	60	Hz	Positive	
1280 × 1024	63.98	KHz	Positive	60	Hz	Positive	
1600 × 1200	75	KHz	Positive	60	Hz	Positive	
1920 × 1080	67.5	KHz	Positive	60	Hz	Positive	



11. Projected Capacitive Touch Panel Characteristics

11.1 Electrical Performance

Parameter	Symbol	Min	Typ	Max	Unit	Note
Input Voltage		-	-	5V		
Response Time		25	-	30	ms	

11.2 Optical Performance

Parameter	Specifications
Light Transmittance	≥ 87%

11.3 Mechanical Performance

Parameter	Specifications
Input Method	Stylus for PCAP or Finger Available
Touch Function	2 Points
Interface	USB
Surface Hardness	≥ 6H
Cover Spec.	Chemically strengthened T=1.8mm Black Printing

11.4 Touch Panel Operation System Support

OS	Version	Interface
Windows	Windows 7 / Windows 9x_ME	USB
	Windows NT4.0	
	Windows CE6.0	
	Windows CE7.0	
	Windows CE.Net_4.x / 5.0	
Linux	Kernel 2.4.x (x86 32bits)	USB
	Kernel 2.6.23 Downward (x86 32 / 64bits)	
	Kernel 2.6.24 Upwards (x86 32 / 64bits · ARM / MIPS)	

11.5 Panel Mount Installation (Mount Clamp and Screw)

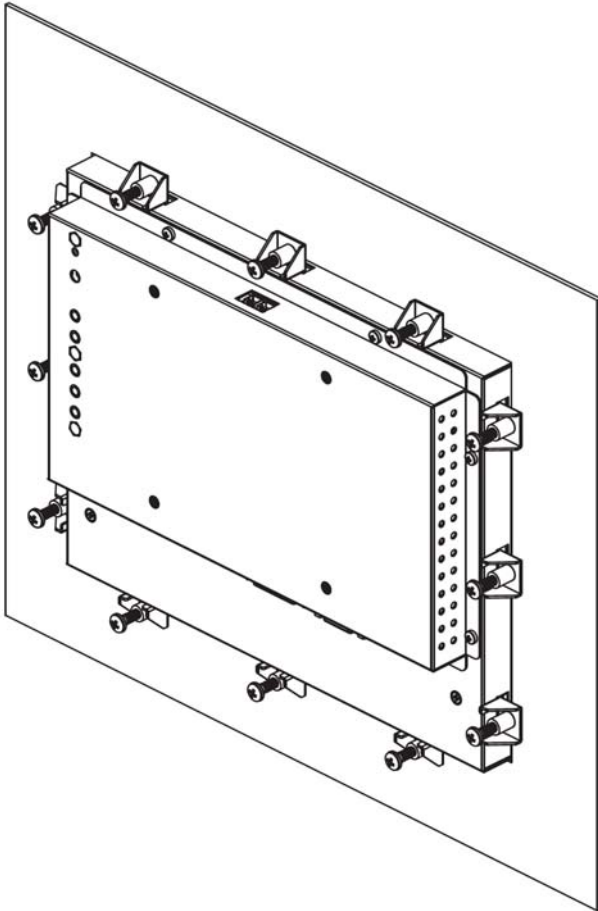

12. Installing the Monitor

12.1 Power cable connection:

Connect the power cord to the AC outlet, and connect the power to the monitor through the AC/DC adapter.

12.2 VGA signal cable connection:

Plug one end of the 15-pin signal cable to the VGA connector at the rear of the PC system and the other end to the Open Frame monitor.

Secure the connectors with the screws on the cable connector at both ends.

12.3 Switch on the power:

Switch on the power switch on the rear cover of the Open Frame Monitor.

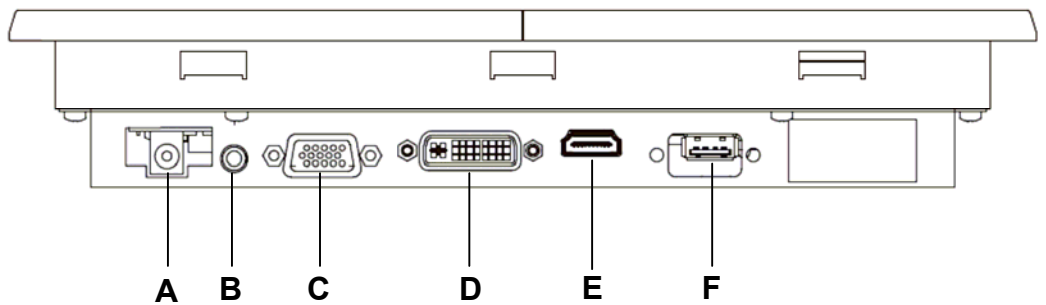

A. DC-In (+12V_{DC} The DC jack core is positive)

B. Line-In : Phone Jack ϕ 3.5

C. VGA D-sub 15 (Female)

D. DVI

E. HDMI

F. USB (For Touch Controller)

13. Accessories (Option)

Before you begin installing the KIT, please make sure that the following materials have been shipped:



A. LASTD12033-FDR



B. LAACD18000-FDR



C. LACABLE068-FDR



D. LACABLE069-FDR



E. LAVGA16000-FDR



F. LAUSB18000-FDR



G. LACABLE070-FDR



H. LAVCD00002-FDR



I. LASPKR0004-FDR



J. LASCW00003-FDR

- A. AC to DC Adapter (L:1500mm,100-240V_{AC} 50-60Hz to +12V_{DC} @ 3.3A, ϕ 2.1)
- B. Power Cord (L:1800mm, Plug Type B for USA)
- C. HDMI Cable (L:2000mm)
- D. DVI Cable (L:1800mm)
- E. VGA Cable (L:1600mm)
- F. USB Cable (L:1800mm)
- G. AUDIO Cable (L:1800mm)
- H. Touch Screen Driver CD Disk / User Manual
- I. Speaker (2.5W @ 4 Ω L:400mm *2 Pieces)
- J. Mount Clamp and Screw *12 Pieces

14. Key Function by OSD

14.1 Menu Operation

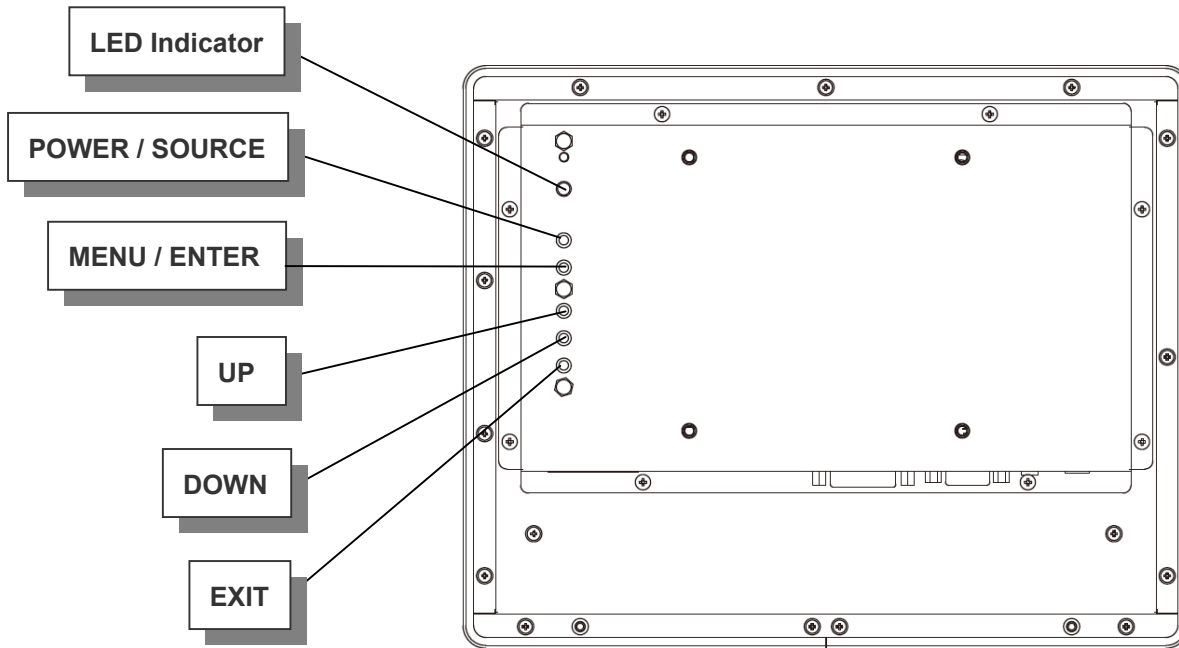

OSD ICON Instructions :



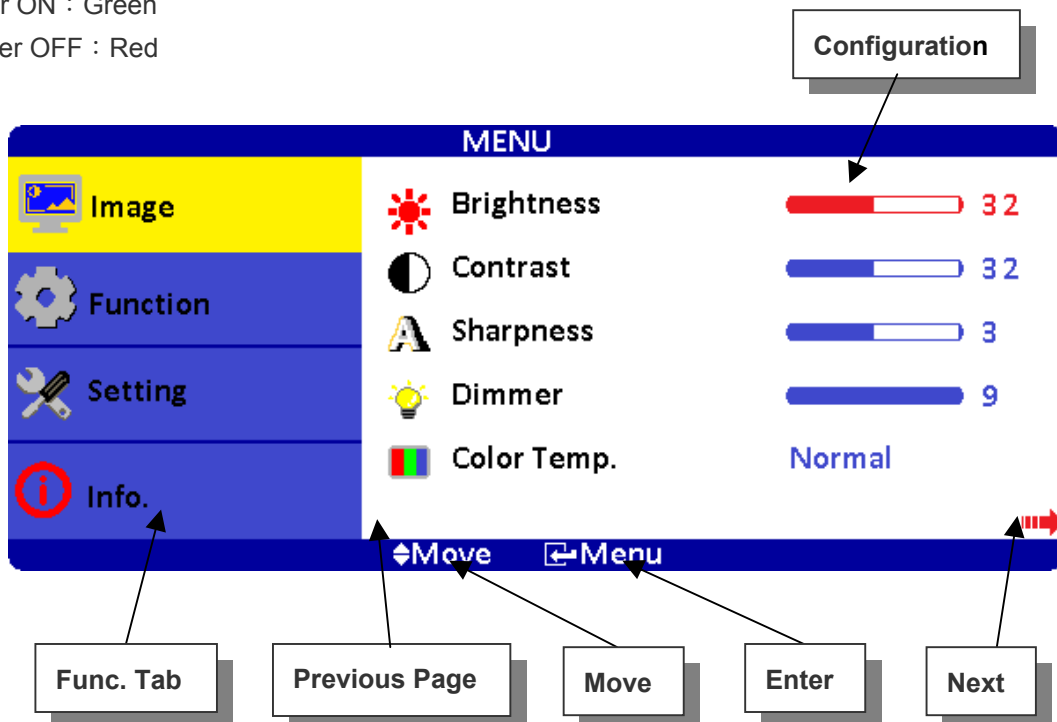







1. POWER / SOURCE : Power On/Off (※Press for 3 secs to turn off) / Input Source Switch
2. MENU / ENTER : (After turning on MENU, only ENTER is available.)
3. UP : Move Upward / Increase Value / Option Switch
4. DOWN : Move Downward / Decrease Value / Option Switch
5. EXIT : Return to Previous Page
6. LED Indicator
 - 6.1 Waiting : Flickering Green
 - 6.2 Power ON : Green
 - 6.3 Power OFF : Red



Overview of the Menu :









Image

Indicator	Meaning	Default	Adjustable range	Remark
	Brightness	32	0~63	Adjust-Bar
	Contrast	32	0~63	Adjust-Bar
	Sharpness	3	1~5	Adjust-Bar
	Dimmer	15	0~15	Adjust-Bar
	Color Temp.	Normal	Normal / Warm / Cool	
	H-Position	0	-25~+25	VGA only
	V-Position	0	-25~+25	VGA only
	Clock	0	-25~+25	VGA only
	Phase	32	0~63	VGA only
	Auto	By different resolution		VGA only
	Exit			



Function

ICON	Meaning	Default	Adjustable range	Function	Remark
	Show Status	On	On / Off	Information of input source	ON: Show ; OFF: Hidden
	Blue Screen	On	On / Off	No signal input shows blue or black screen.	ON: Blue ; OFF: Black
	Auto Power On	On	On / Off	Modules turns on automatically w/o power input.	ON: Auto ; OFF: Manual
	Detect Source	On	On / Off	Auto detect input source.	ON: Auto ; OFF: Normal
	Auto Power Saving	Off	6s / 15s / 30s / Off	Modules go ready when no input source is detected.	ON: Auto ; OFF: Normal
	Auto Sleep	Off	15M / 30M / 60M / Off	Modules go sleep when set timing is out.	ON: Auto ; OFF: Normal
	Exit				

Note : After configuration is set, **RESET** won't restore to default setting.



Setting

Indicator	Meaning	Default	Adjustable range	Remark
	Source	VGA	VGA / DVI / HDMI	Reset won't restore to default setting
	Volume	32	0~63	
	Mute	Off	On / Off	On : Mute , Off : Sound
	Language	English	English / 中文 / 日本語 / 한국의 / Française / Deutsch / Italiano / Española / Português	Reset won't restore to default setting
	Reset			Restore to default
	Exit			



Info.

MENU

Image	Source : VGA
Function	Resolution : 1024x768
Setting	H-Position : 48.2KHz V-Position : 59.8Hz
Information	Program Ver : 1.00 Command Ver : 1.00

◀ Move ▶ Exit / Menu

Hot Key When OSD Menu is Off :

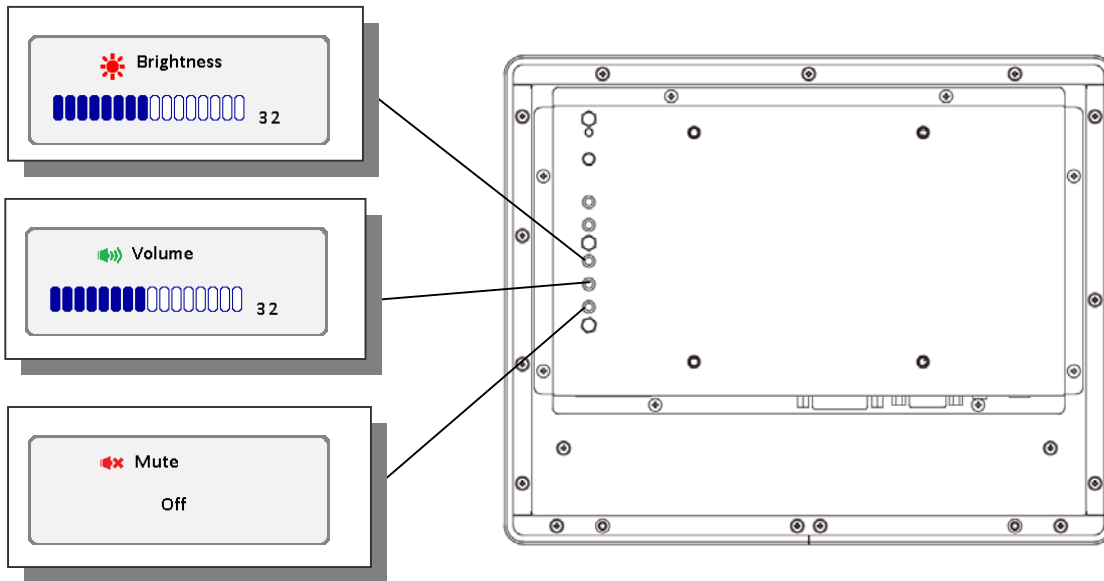

Information of Input Source and Functionality :



[Source] : Input Signal Switch

Overview of Input Signals :

Indicator	Interface
	VGA
	DVI
	HDMI

